

COMBINED SCIENCE

5129/12

Paper 1 Multiple Choice

May/June 2016

1 hour

Additional Materials: Multiple Choice Answer Sheet
 Soft clean eraser
 Soft pencil (type B or HB is recommended)



READ THESE INSTRUCTIONS FIRST

Write in soft pencil.

Do not use staples, paper clips, glue or correction fluid.

Write your name, Centre number and candidate number on the Answer Sheet in the spaces provided unless this has been done for you.

DO NOT WRITE IN ANY BARCODES.

There are **forty** questions on this paper. Answer **all** questions. For each question there are four possible answers **A, B, C** and **D**.

Choose the **one** you consider correct and record your choice in **soft pencil** on the separate Answer Sheet.

Read the instructions on the Answer Sheet very carefully.

Each correct answer will score one mark. A mark will not be deducted for a wrong answer.

Any rough working should be done in this booklet.

A copy of the Periodic Table is printed on page 16.

Electronic calculators may be used.

This document consists of **15** printed pages and **1** blank page.

- 1 Cells contain structures V, W, X, Y and Z. Each structure has a specific function as shown in the table.

structure	function
V	strengthens and supports the cell
W	absorbs light energy
X	is where chemical reactions take place
Y	controls the activities of the cell
Z	controls what enters and leaves the cell

Which pair of structures are **not** found in an animal cell?

- A** V and W **B** V and Z **C** W and X **D** X and Y

- 2 Which statement describes osmosis?

- A** The passage of water molecules from a region of their higher concentration to a region of their lower concentration through a partially permeable membrane.
- B** The passage of water molecules from a region of their higher concentration to a region of their lower concentration through a permeable membrane.
- C** The passage of water molecules from a region of their lower concentration to a region of their higher concentration through a partially permeable membrane.
- D** The passage of water molecules from a region of their lower concentration to a region of their higher concentration through a permeable membrane.

- 3 What is the name of the group of proteins which act as catalysts in biological reactions?

- A** amino acids
- B** carbohydrates
- C** enzymes
- D** hormones

- 4 A pupil investigates how minerals affect plant growth. He sets up four solutions as shown in the diagram.

In which solution would the plant be unable to make amino acids and proteins?

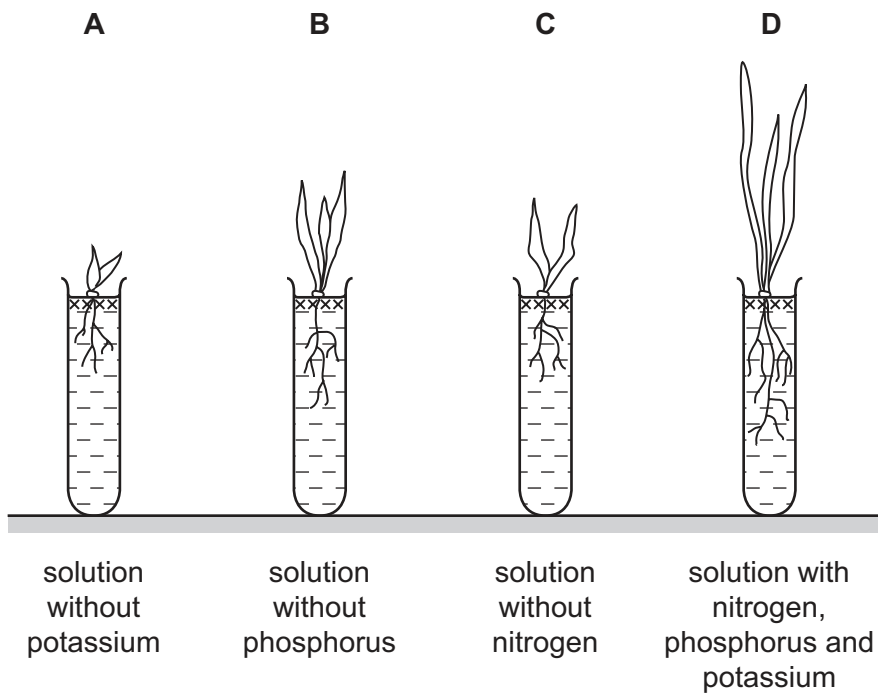

- 5 In which part of the alimentary canal does both digestion and absorption occur?

- A** colon
- B** ileum
- C** rectum
- D** stomach

- 6 Why do plants wilt?

- A** Sugars are made by photosynthesis faster than water is lost by transpiration.
- B** Sugars move down the phloem faster than water is absorbed through root hair cells.
- C** Water is lost by transpiration faster than water is absorbed by root hair cells.
- D** Water moves up the xylem faster than sugars move down the phloem.

- 7 The diagram shows a human heart. The four valves in the heart are labelled V, W, X and Y.

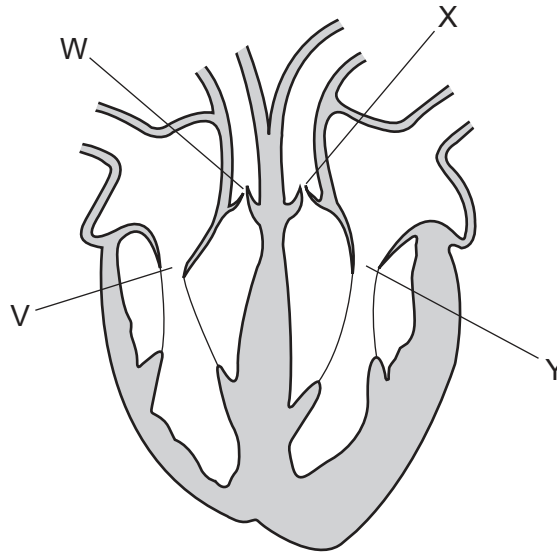

What is the state of the valves when blood leaves the heart through the arteries?

	V	W	X	Y
A	closed	closed	open	open
B	closed	open	open	closed
C	open	closed	closed	open
D	open	open	closed	closed

- 8 During exercise, lactic acid may build up in muscles.

What is the cause of this build-up?

- A** increased aerobic respiration in muscles
 - B** increased anaerobic respiration in muscles
 - C** increased blood flow to muscles
 - D** increased heat production in muscles
- 9 How does the carbon dioxide and urea concentration in blood leaving the kidneys compare to that of blood entering the kidneys?

	carbon dioxide concentration	urea concentration
A	higher	higher
B	higher	lower
C	lower	higher
D	lower	lower

10 Which muscle action causes light rays from a near object to be focused on the retina?

- A ciliary muscles contract
- B ciliary muscles relax
- C circular iris muscles contract
- D circular iris muscles relax

11 Which descriptions of alcohol are correct?

	alcohol is a depressant	is broken down by the liver
A	no	no
B	no	yes
C	yes	no
D	yes	yes

12 Biologists link plants and animals in food chains and food webs according to the transfer of energy.

What is the principal source of this energy?

- A photosynthesis
- B plants
- C respiration
- D sun

13 Which row shows an example of each type of birth control?

	chemical	hormonal	surgical
A	condom	spermicide	vasectomy
B	pill	vasectomy	condom
C	spermicide	pill	vasectomy
D	vasectomy	condom	pill

14 The diagram shows some laboratory apparatus.

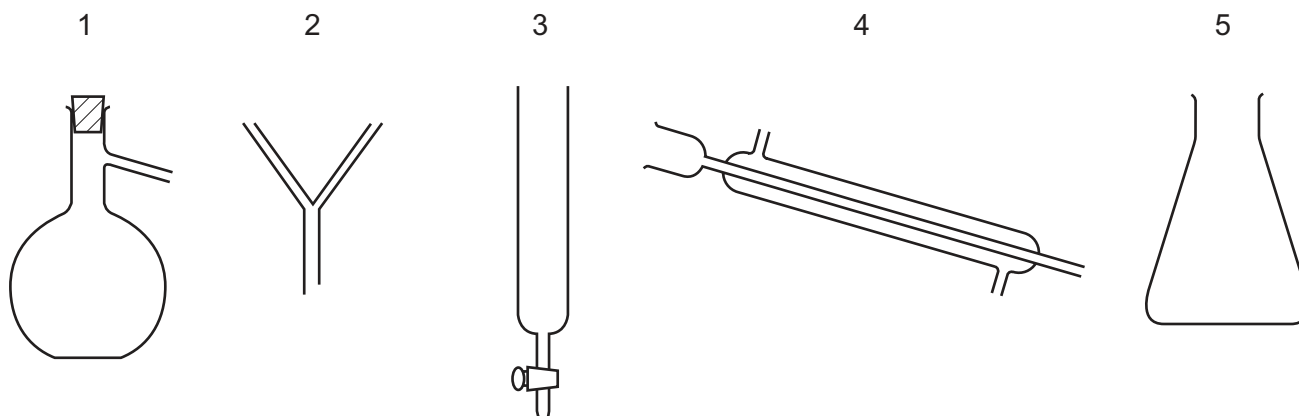

Which pieces of apparatus are needed to produce and collect pure water from seawater?

- A 1, 2 and 4 B 1, 4 and 5 C 2 and 5 D 3 and 5

15 An atom of sodium is represented by ${}_{11}^{23}\text{Na}$.

Which statement about this atom is **not** correct?

- A The atom contains 11 electrons.
 B The atom contains 11 neutrons.
 C The atom contains 11 protons.
 D The nucleus of the atom contains 23 particles.

16 The table shows the proton (atomic) numbers of three elements.

element	proton (atomic) number
X	3
Y	9
Z	10

Which statement about X, Y and Z is correct?

- A X and Y can combine to form a covalent compound XY.
 B X and Y can combine to form an ionic compound XY.
 C Y and Z can combine to form a covalent compound YZ.
 D Y and Z can combine to form an ionic compound YZ.

17 The diagram shows the structure of carbonyl dichloride (phosgene).

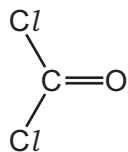

Which 'dot and cross' diagram shows the arrangement of the outer electrons in a molecule of carbonyl dichloride?

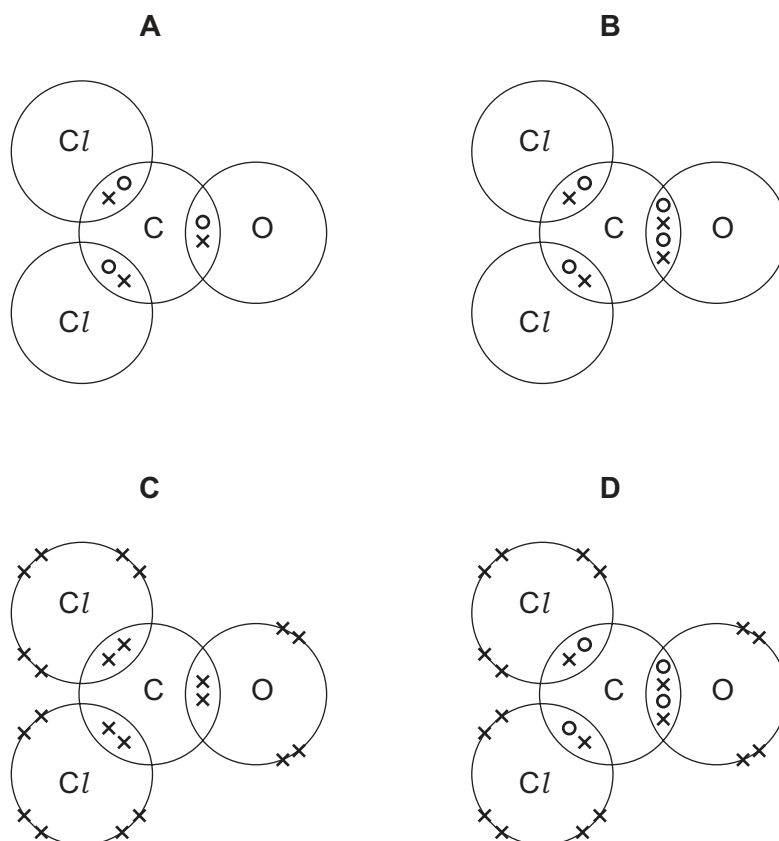

18 Sodium metal reacts with water to produce a solution of sodium hydroxide and hydrogen.

Which equation is balanced and shows the correct state symbols?

- A** $\text{Na(s)} + \text{H}_2\text{O(l)} \rightarrow \text{NaOH(aq)} + \text{H}_2\text{(g)}$
- B** $\text{Na(s)} + \text{H}_2\text{O(aq)} \rightarrow \text{NaOH(aq)} + \text{H}_2\text{(g)}$
- C** $2\text{Na(s)} + 2\text{H}_2\text{O(aq)} \rightarrow 2\text{NaOH(aq)} + \text{H}_2\text{(g)}$
- D** $2\text{Na(s)} + 2\text{H}_2\text{O(l)} \rightarrow 2\text{NaOH(aq)} + \text{H}_2\text{(g)}$

19 Which statement about all acids is correct?

- A They contain both hydrogen and oxygen.
- B They give ammonia with an ammonium salt.
- C They have a pH value below 7.
- D They react with all metals to form hydrogen.

20 The table shows the melting point and boiling point of some Group I elements.

element	melting point /°C	boiling point /°C
Li	180	1330
K	64	774
Rb	39	688

Which row gives the melting point and boiling point of sodium?

	melting point /°C	boiling point /°C
A	58	750
B	98	890
C	102	1525
D	196	1210

21 What are the general physical properties of a metal?

	electrical conductor	malleable
A	no	no
B	no	yes
C	yes	no
D	yes	yes

22 Which statement about obtaining metals from their ores is **not** correct?

- A Copper is obtained from its ore by heating with carbon as it is more reactive than carbon.
- B Iron is obtained from its ore by carbon reduction as it is less reactive than carbon.
- C Less reactive metals are easier to obtain from their ores.
- D More energy is required to obtain a more reactive metal from its ore.

23 What is **not** a use of oxygen?

- A as an aid to respiration for people with breathing difficulties
- B in the manufacture of steel from iron
- C in the purification of water
- D in welding

24 Ammonia is manufactured from hydrogen and nitrogen using the Haber process.

Which conditions are used?

	temperature / °C	pressure / atm
A	100	2
B	100	200
C	450	2
D	450	200

25 Six different names or formulae for organic compounds are listed below.

ethane $\text{CH}_3\text{CH}_2\text{CH}_3$

ethanol $\text{CH}_3\text{CH}=\text{CH}_2$

ethene $\text{CH}_3\text{CH}_2\text{OH}$

Which row shows the number of different compounds present in the list?

	number of different alkanes	number of different alkenes	number of different alcohols
A	1	2	2
B	1	3	2
C	2	2	1
D	2	3	1

26 Decane is a hydrocarbon with the molecular formula $\text{C}_{10}\text{H}_{22}$.

Which description of decane is correct?

- A saturated alkane
- B saturated alkene
- C unsaturated alkane
- D unsaturated alkene

27 The molecular formulae for four hydrocarbon molecules, W, X, Y and Z, are shown.

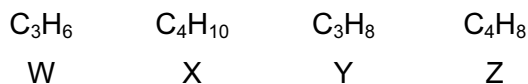

Which molecules change aqueous bromine from yellow-brown to colourless?

- A** W and Y **B** W and Z **C** X and Y **D** X and Z

28 Which row contains a suitable quantity and unit for measurements made using a micrometer and a measuring cylinder?

	micrometer	measuring cylinder
A	length in mm	volume in cm^3
B	length in m	volume in m^3
C	volume in cm^3	length in mm
D	volume in m^3	length in m

29 The velocity of a moving car is constant during part of a journey.

What is the acceleration during this time?

- A** decreasing all the time
B increasing all the time
C increasing, then decreasing to zero
D zero all the time

30 The beam shown in the diagram is not balanced. The mass of the beam can be ignored.

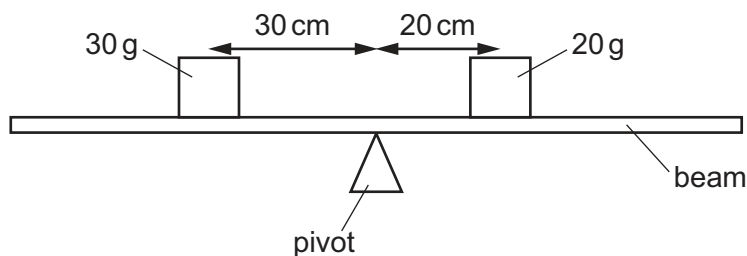

Which change does **not** balance the beam?

- A** changing the 20 g mass to 45 g
B changing the 30 g mass to 15 g
C moving the 20 g mass to the right so that it is 45 cm from the pivot
D moving the pivot 10 cm to the left

- 31 A car travels along a level road.

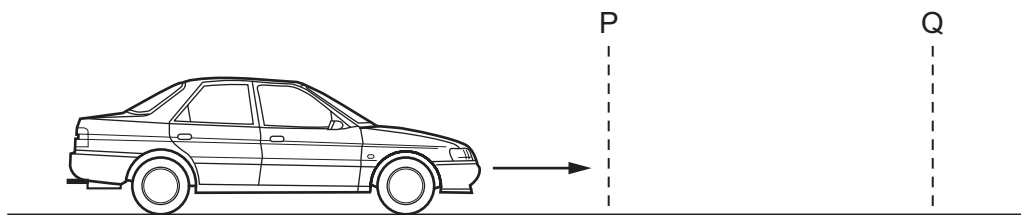

At P, the car has 10 kJ of kinetic energy.

Between P and Q the energy input from the petrol is 50 kJ, and the car loses 35 kJ of energy to the environment.

What is the kinetic energy of the car at Q?

- A** 5 kJ **B** 25 kJ **C** 45 kJ **D** 60 kJ
- 32 Compared to a liquid in-glass laboratory thermometer, a liquid in-glass clinical thermometer has
- A** a larger range and a higher sensitivity.
B a larger range and a lower sensitivity.
C a smaller range and a higher sensitivity.
D a smaller range and a lower sensitivity.
- 33 A path is made by laying concrete slabs on a cold day. Gaps are left between the slabs.

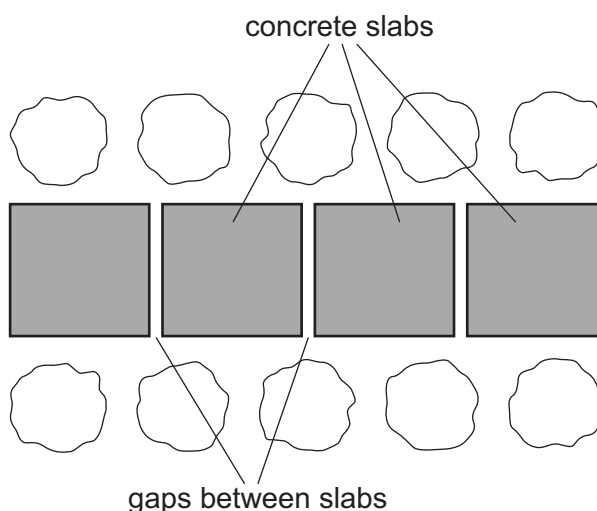

On a hot day how does the size of each slab and the gaps between the slabs change?

- A** The slabs and the gaps both become larger.
B The slabs and the gaps both become smaller.
C The slabs become larger and the gaps become smaller.
D The slabs become smaller and the gaps become larger.

34 The diagram shows the outline of a water wave.

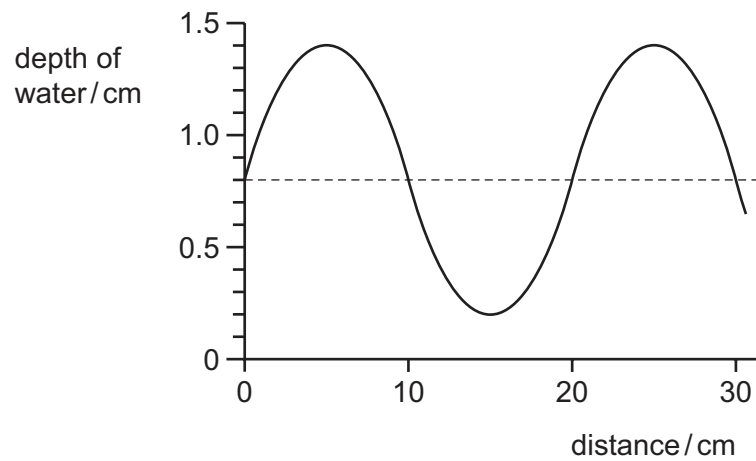

What are the values of the amplitude and the wavelength of the wave?

	amplitude / cm	wavelength / cm
A	0.6	10
B	0.6	20
C	1.2	10
D	1.2	20

35 Which description of electromagnetic waves is correct?

- A** longitudinal waves that can travel in a vacuum
- B** longitudinal waves that cannot travel in a vacuum
- C** transverse waves that can travel in a vacuum
- D** transverse waves that cannot travel in a vacuum

36 The diagram shows a battery of e.m.f. 6V connected to two resistors, P and Q.

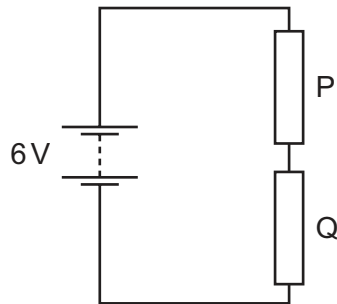

When 2 C of charge passes round the circuit, 4 J of energy is dissipated in resistor P.

How much energy is produced by the battery and how much energy is dissipated in resistor Q?

	energy produced by battery / J	energy dissipated in resistor Q / J
A	6	2
B	6	4
C	12	4
D	12	8

37 Current from an electrical source enters an arrangement of four branches at junction P.

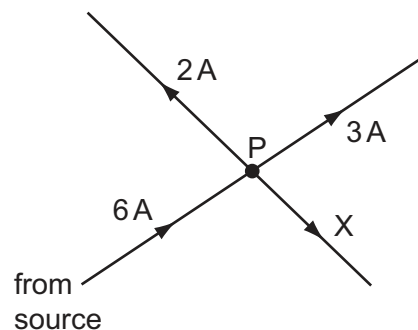

What is the current in branch X?

- A** 1A **B** 3A **C** 4A **D** 11A

38 The simple generator shown contains brushes and slip rings.

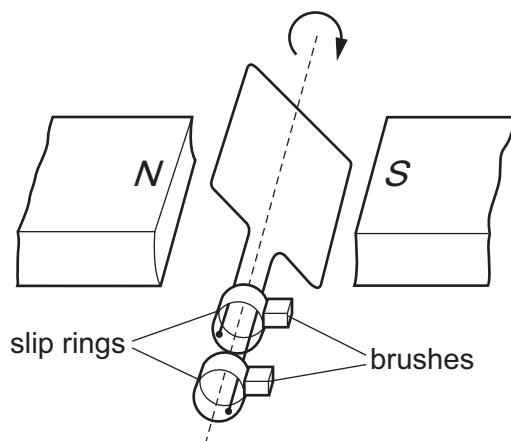

Which material is used for the brushes and what is the output from the generator?

	brush material	output from the generator
A	carbon	a.c.
B	carbon	d.c.
C	glass	a.c.
D	glass	d.c.

39 Two nuclides of neon are represented by the symbols below.



One nuclide contains more particles than the other.

What are these extra particles?

- A** electrons
- B** ions
- C** neutrons
- D** protons

40 Which equation represents the decay of the nuclide ${}_{88}^{226}\text{Ra}$ by the emission of an alpha-particle?

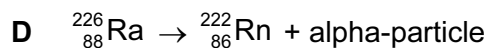
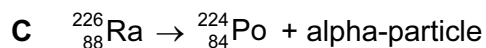
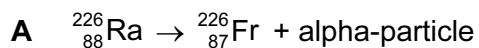

BLANK PAGE

Permission to reproduce items where third-party owned material protected by copyright is included has been sought and cleared where possible. Every reasonable effort has been made by the publisher (UCLES) to trace copyright holders, but if any items requiring clearance have unwittingly been included, the publisher will be pleased to make amends at the earliest possible opportunity.

To avoid the issue of disclosure of answer-related information to candidates, all copyright acknowledgements are reproduced online in the Cambridge International Examinations Copyright Acknowledgements Booklet. This is produced for each series of examinations and is freely available to download at www.cie.org.uk after the live examination series.

Cambridge International Examinations is part of the Cambridge Assessment Group. Cambridge Assessment is the brand name of University of Cambridge Local Examinations Syndicate (UCLES), which is itself a department of the University of Cambridge.

The Periodic Table of Elements

		Group															
I	II	III	IV	V	VI	VII	VIII										
3 Li lithium 7	4 Be beryllium 9	5 B boron 11	6 C carbon 12	7 N nitrogen 14	8 O oxygen 16	9 F fluorine 19	10 Ne neon 20										
11 Na sodium 23	12 Mg magnesium 24	13 Al aluminium 27	14 Si silicon 28	15 P phosphorus 31	16 S sulfur 32	17 Cl chlorine 35.5	18 Ar argon 40										
19 K potassium 39	20 Ca calcium 40	21 Sc scandium 45	22 Ti titanium 48	23 V vanadium 51	24 Cr chromium 52	25 Mn manganese 55	26 Fe iron 56	27 Co cobalt 59	28 Ni nickel 59	29 Cu copper 64	30 Zn zinc 65	31 Ga gallium 70	32 Ge germanium 73	33 As arsenic 75	34 Se selenium 79	35 Br bromine 80	36 Kr krypton 84
37 Rb rubidium 85	38 Sr strontium 88	39 Y yttrium 89	40 Zr zirconium 91	41 Nb niobium 93	42 Mo molybdenum 96	43 Tc technetium —	44 Ru ruthenium 101	45 Rh rhodium 103	46 Pd palladium 106	47 Ag silver 108	48 Cd cadmium 112	49 In indium 115	50 Sn tin 119	51 Sb antimony 122	52 Te tellurium 128	53 I iodine 127	54 Xe xenon 131
55 Cs caesium 133	56 Ba barium 137	57–71 lanthanoids	72 Hf hafnium 178	73 Ta tantalum 181	74 W tungsten 184	75 Re rhenium 186	76 Os osmium 190	77 Ir iridium 192	78 Pt platinum 195	79 Au gold 197	80 Hg mercury 201	81 Tl thallium 204	82 Pb lead 207	83 Bi bismuth 209	84 Po polonium —	85 At astatine —	86 Rn radon —
87 Fr francium —	88 Ra radium —	89–103 actinoids	104 Rf rutherfordium —	105 Db dubnium —	106 Sg seaborgium —	107 Bh bohrium —	108 Hs hassium —	109 Mt meitnerium —	110 Ds darmstadtium —	111 Rg roentgenium —	112 Cn copernicium —	114 Fl flerovium —	116 Lv livermorium —	—	—	—	—

1 H hydrogen 1

atomic number atomic symbol name relative atomic mass
--

57 La lanthanum 139	58 Ce cerium 140	59 Pr praseodymium 141	60 Nd neodymium 144	61 Pm promethium —	62 Sm samarium 150	63 Eu europium 152	64 Gd gadolinium 157	65 Tb terbium 159	66 Dy dysprosium 163	67 Ho holmium 165	68 Er erbium 167	69 Tm thulium 169	70 Yb ytterbium 173	71 Lu lutetium 175
89 Ac actinium —	90 Th thorium 232	91 Pa protactinium 231	92 U uranium 238	93 Np neptunium —	94 Pu plutonium —	95 Am americium —	96 Cm curium —	97 Bk berkelium —	98 Cf californium —	99 Es einsteinium —	100 Fm fermium —	101 Md mendelevium —	102 No nobelium —	103 Lr lawrencium —

lanthanoids

actinoids

The volume of one mole of any gas is 24 dm³ at room temperature and pressure (r.t.p.)